

ARTIKAL

138201

Item

BATERIJA ZA SUDOPERU

sink mixer

SLIKA PROIZVODA
Product picture



TEHNIČKA SKICA
Technical draft

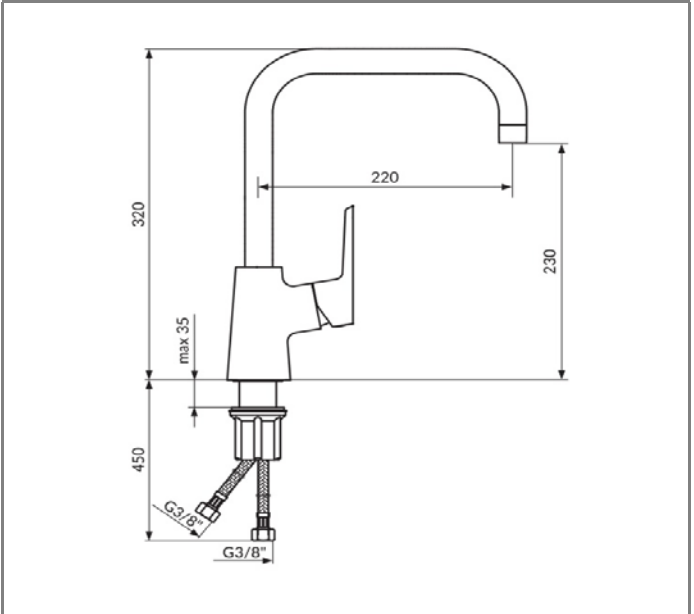

TEHNIČKI PODACI

Jednoručna baterija
Montiranje na jedan otvor
NEOPERL® PERLATOR® HONEYCOMB®
Keramički mešač KEROX® 35 A NDO HWS
360° rotacioni izliv
FaST35 set za brzo pričvršćenje
NEOPERL® SPX® priključna creva
Klasa bučnosti II

TECHNICAL DETAILS

Single lever mixer
Single hole mounted
Aerator NEOPERL® PERLATOR® HONEYCOMB®
Ceramic cartridge KEROX® 35 A NDO HWS
360° swivel spout
FaST35 fastening set
NEOPERL® SPX® flexible connecting hoses
Noise level II

RADNI USLOVI

Maksimalni radni pritisak: 5 bar
Preporučeni radni pritisak: 3 bar
Minimalni radni pritisak: 1 bar
Maksimalna dozvoljena temperatura: 80°C
Preporučena temperatura vode: 60°C

WORKING CONDITIONS

Max. working pressure : 5 bar
Suggested working pressure : 3 bar
Min. working pressure : 1 bar
Max. working temperature : 80°C
Suggested max. water temperature : 60°C

www.rosan.rs

Srbija, 24420 Kanjiža, Dušana Popovića 10.

tel.+381 24-876-744 fax +381 24-876-756, info@rosan.rs

STOLZ